

AG SINGLE AXES GATE BOPLAN SAFETY GATES

Revision: 8 February 2024 4:12 PM
Boplan reference: AG0110...

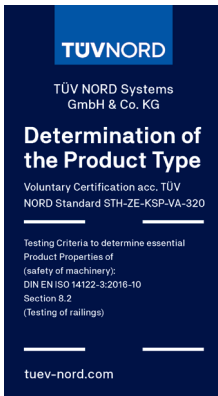

PRODUCT SPECIFICATIONS

APPLICATION	
Environment	Ground-level applications. (Use Double Axes Gate, with an opening up to 950mm, for fall protection). Indoor and outdoor environment. Extremely saline environments. Chemical industries near corrosive, chemical substances.
Features	Self-closing safety gate (gravity). Opens to the left or to the right. Opens over an angle of 120°. Can be cut on size (Cutting will be charged separately). Can be mounted on different type of poles or profiles. Designed with rounded elements that prevent snags in clothing or limbs. Colored into the mass. Eco-friendly with 100% recyclable material. Non - corrosive. UV-resistant. Fire class V0 according to UL94 (US Standard for Safety of Flammability of Plastics). Impervious to most chemical products*. Positively tested up to 150.000 cycles (open/close).
Advisory speed	Not intended for vehicle impact.
MATERIAL	
Gate / hinge / stopper	High Impact Thermoplastic Engineered Polymer (HI-TEP) - Fire class V0* - Non conductive
Fixations	Stainless steel A4
STANDARD COLORS	
Gate / hinge / stopper	Yellow Ral 1003 (Signal Yellow)
FIXATIONS (included)	
To fix hinge	<p>Fix hinge block to plate: Bolts: M10x30mm - stainless steel (2x) Washer M10 - stainless steel (2x)</p> <p>Mount hinge assembly to surface: Bolts: M12x80mm - stainless steel (2x) Washer M12 - stainless steel (4x) Locknut M12 - stainless steel (2x)</p> 
To fix support block	<p>Bolts: M12x80mm - stainless steel (1x) Washer M12 - stainless steel (2x) Locknut M12 - stainless steel (1x)</p> 

*Ask your local sales office for resistance to specific chemicals.

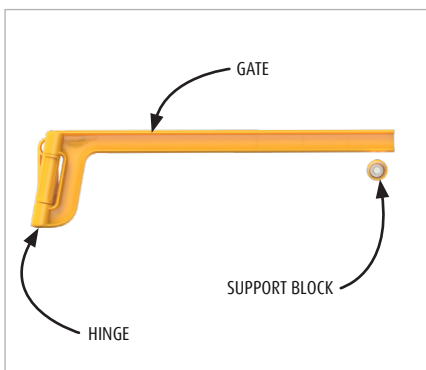



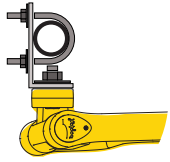
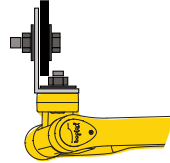
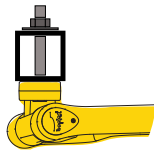
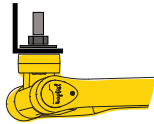

FEATURES AND FUNCTIONALITY - SINGLE AXES GATE

ATTACH TO	
Round tube	
I-Profile	
Square tube	
L-Profile	

REQUIREMENTS	
Installation	Always need to close against a post.
Operational temperature	-20°C up to 40°C
Food proof	No
Use	Always to be opened manually. Not indented to absorb vehicle impact.
SIZE	
Section gate	(H) 65 mm x (W) 40 mm
Weight	3,90 kg (version with an opening of 1130 mm; incl hinge, fixations,...) 3,50 kg (version with an opening of 870 mm; incl hinge, fixations,...)
COMPLIANCE	
The Single Axes Gate, with an opening up to 870mm, DOES comply with safety standard EN14122-3 chapter 8.2 (tested on strength and TÜV certified, with certificate available upon request).	
The Single Axes Gate DOES NOT comply with safety standard EN14122-3 chapter 7.1.4. (But the Double Axes Gate, with an opening up to 950mm, does) due to the absence of a knee rail.	

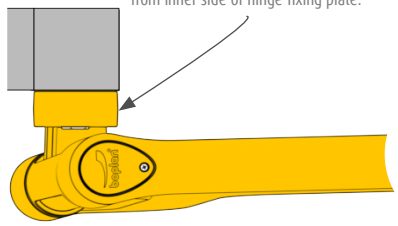
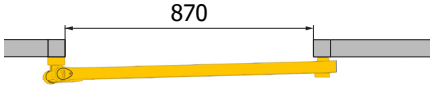
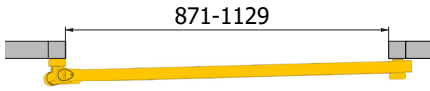
REFERENCES - SINGLE AXES GATE

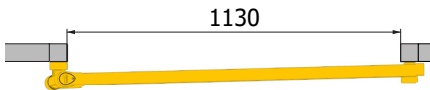
SINGLE AXES GATE			
	Gate opening (mm)		
AG0111-0939-A4-YE			 <p>Maximum gate opening is measured from inner side of hinge fixing plate.</p>
AG0110-0940-A4-YE			
AG0111-1199-A4-YE			
AG0110-1200-A4-YE			

SINGLE AXES GATE - ACCESSORIES	
AG0199-0004-0016A2	<p>Magnetic locking system 16kg pullpower (incl fixations)</p> 
AG0199-0001-0050BL	<p>Safety knob Black Rubber (incl fixations)</p> 
AG0199-0005-00160YE	<p>Support Block (incl fixations)</p> 

SINGLE AXES GATE - ACCESSORIES	
AG0199-0006-0055A4	<p>L-Bracket (incl fixations)</p> 
AG0199-0005-0245A4	<p>Pipe fixing system Tubes Ø37-52mm (incl fixations)</p> 

REFERENCES - SINGLE AXES GATE

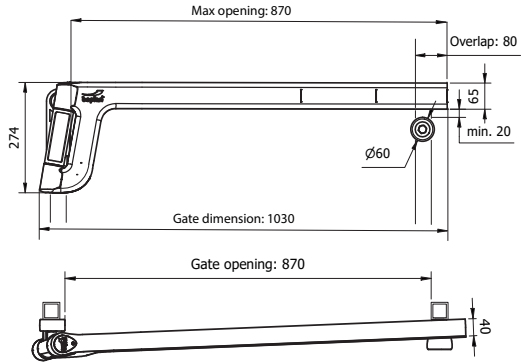

Single Axes Gate - opening 870 mm

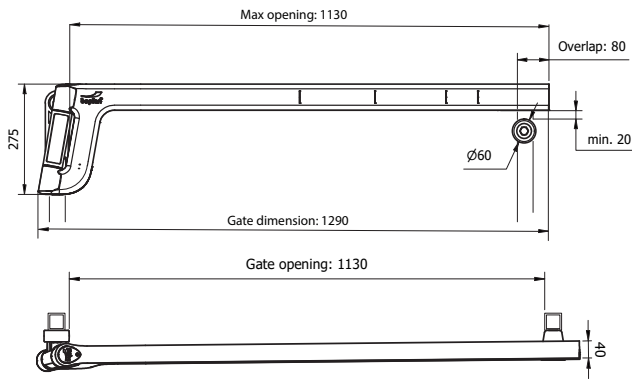
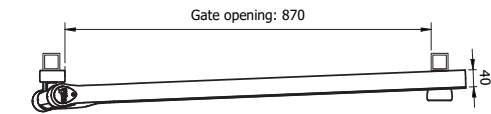

Single Axes Gate - opening 1130 mm

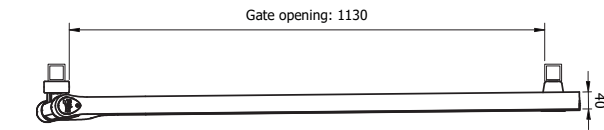

Axes Gate hinge dimensions

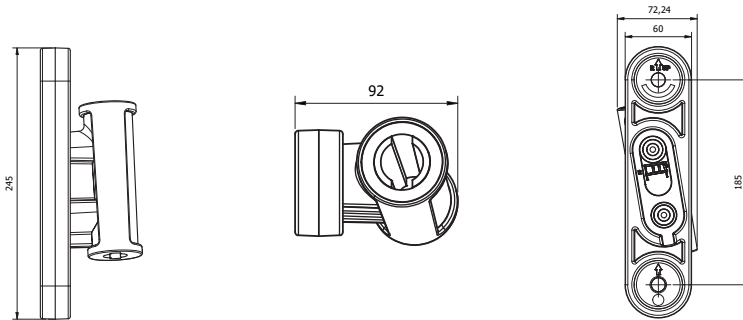

Gravity closing system

